

Joto SwingAway Press Manual

Model No.: E-HP-JSA-1620



JOTOTM
Bringing images to lifeTM

Safety Instructions

For Use By Qualified Personnel Only

When using your Heat Press, basic precautions should always be followed, including the following:

Read all instructions.

Use heat press only for its intended use.

Always keep the heat press dry. Do not get the heat press wet to reduce the risk of electric shock. Do not store heat press in a wet/ damp area.

Never pull cord to disconnect the power. Instead, grasp plug and pull to disconnect from power outlet.

Make sure you protect the power cord by keeping it away from hot surfaces. Avoid placing objects on top of the cord. This could cause damage to the cord and could be a fire hazard risk.

Do not operate heat press with a damaged cord or if the equipment has been damaged. To prevent risks of injury, please do not disassemble or attempt to repair the heat press by yourself if you are not qualified to do so. Instead, call or take it to a qualified service person for examination and repair. Incorrect assembly or repair could increase the risk of fire, electric shock, or injury to persons when the equipment is used.

If heat press being used by or near children, please make sure that it is supervised. Do not leave equipment unattended while connected.

Metal parts on the press can become hot. Avoid touching the hot metal parts to prevent burns. Proceed with caution when using the heat press.

To reduce the likelihood of circuit overload, Joto recommends to use a dedicated circuit if possible.

Make sure that the cord is safely secured so it cannot be pulled or tripped over.

If you need to use an extension cord, make sure you use a 20 amperage rated cord. Cords rated below 20 amperage can overheat. Make sure that the extension cord is safely secured so it cannot be pulled or tripped over.

Note: This heat press should not be set to exceed 400°F (200°C). Setting the press temperature to above 400°F (200°C) may cause a fire hazard.

Be careful of the Auto Release feature. Press handle can injure body parts when auto releasing. Stand clear of auto-release path.



PLEASE KEEP THE BOX THAT YOUR HEAT PRESS ARRIVED IN, ALONG WITH ALL ORIGINAL PACKAGING.

Congratulations on your purchase of a Joto Swing Away Heat Press! In order to work professionally with the machine and start production, please make sure you read this manual carefully.

Reproduction of this manual requires written consent from Joto. Errors and amendments of technical details excepted, all rights reserved. Joto is not liable for any direct or indirect damages caused by the use of this product.

Table of Contents

Safety.....	2
Introduction	3
Heat Press Overview	4
Machine Parts Diagram	5
Setting Up Your Heat Press	6
Operating Instructions	7
Maintenance	8
Heat Pressing Guide	9-10
Schematic Diagram.....	11
Expanded View	12-13
Circuit Diagram.....	14
Warranty.....	15
Contact	16

Heat Press Overview



Technical Specs

Model No.:	E-HP-JSA-1620
Machine Type:	Swing Away Auto Release
Machine Size:	34.25" x 19.29" x 27.55" (870mm x 490mm x 700mm)
Heat platen Size:	16" X 20"
Controller	GY-06 Digital Controller
Max Print Article Size:	16" x 20" x 1.6"
Voltage:	220V/1Phase; 110V/1Phase
Power:	220V/1.8KW; 110V/1.2KW
Time Range:	0-999 Seconds
Maximum Temp:	491°F (225°C)
Packing Size:	37" x 25.1" x 35.03" (940mm x 640mm x 890mm)
Gross Weight:	187.39lb (82.5kg)

Note: This heat press should not be set to exceed 400°F (200°C). Setting the press temperature to above 400°F (200°C) may cause a fire hazard.

Heat Press Overview

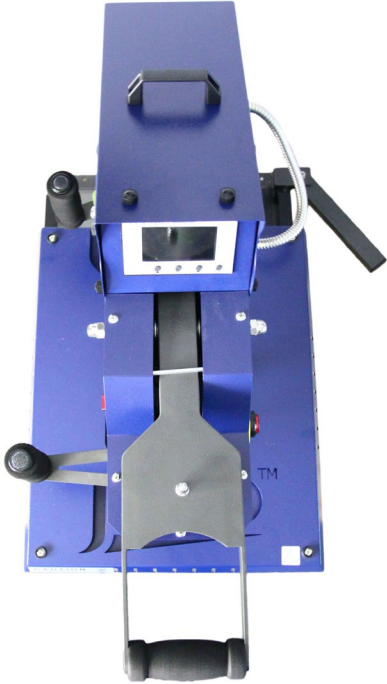

TOP VIEW



FRONT (SWUNG) VIEW



FRONT VIEW

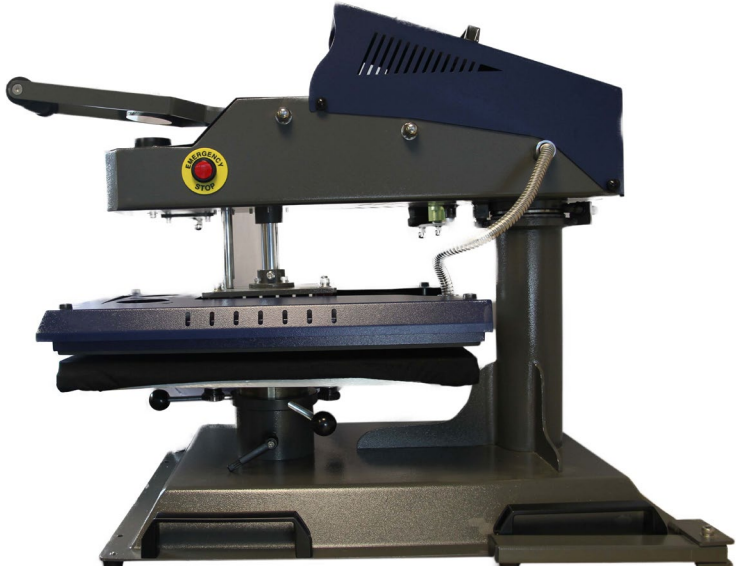

RIGHT VIEW

Machine Parts Diagram

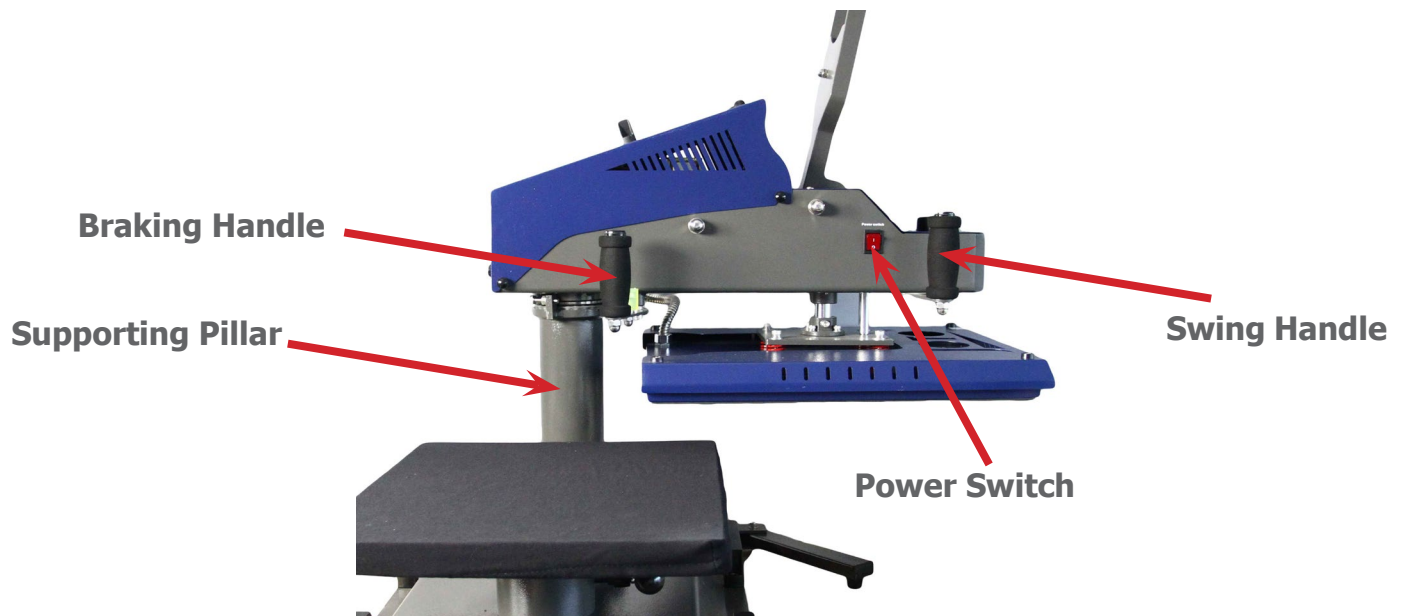
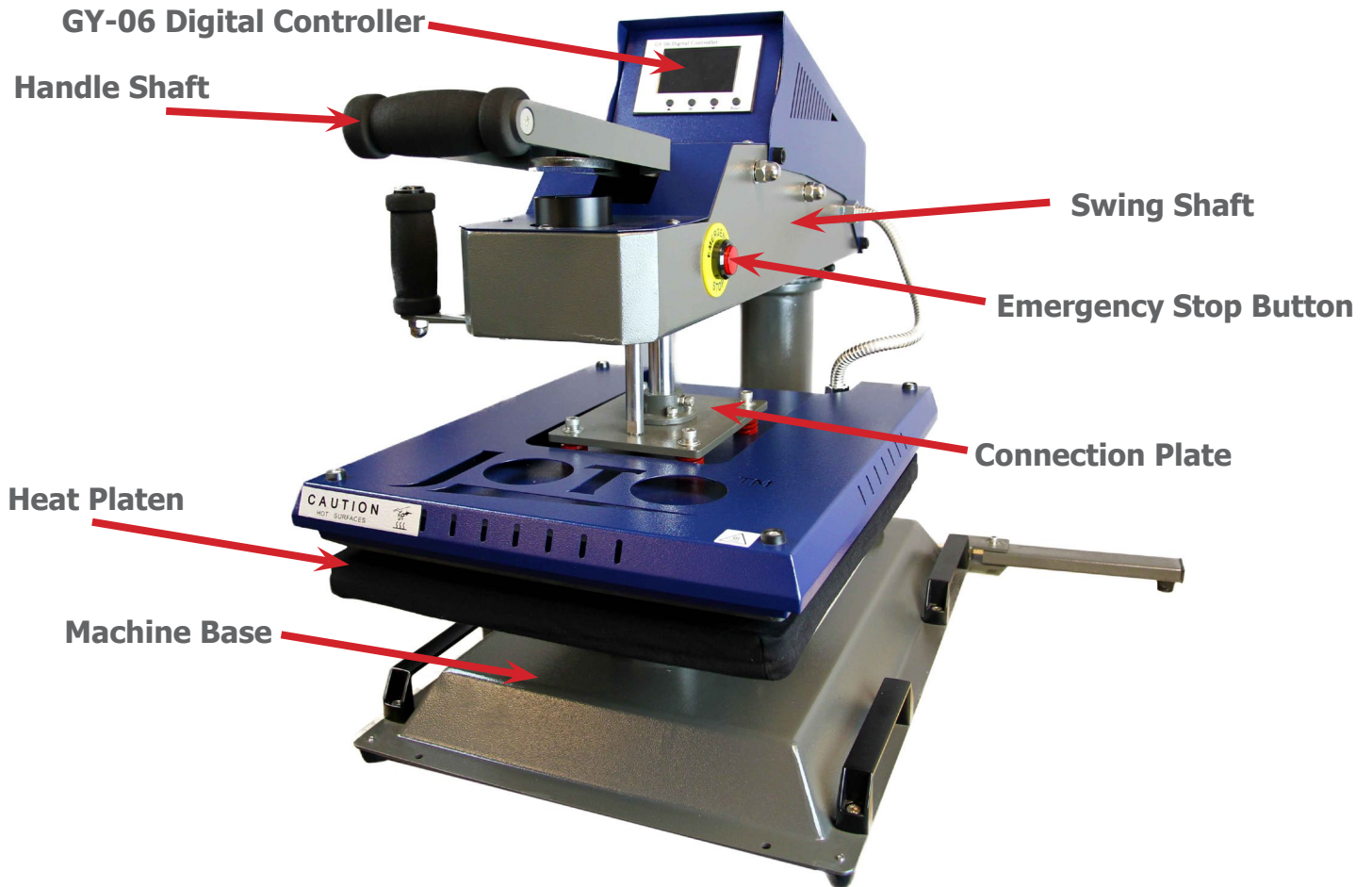

Setting Up Your Heat Press

Turning On Your Heat Press

Turn the Main Power Switch on. The Main Power Switch is at the left side of the heat press.

Current temperature, set temperature, current time, set time will display.

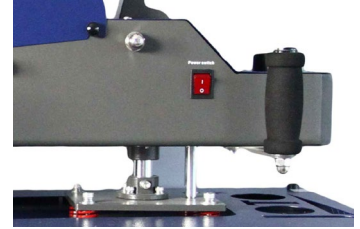

How to Read The Display

- 1.) Left side PV value = Current Temperature
- 2.) Right side PV value = Current Time
- 3.) Left side SV value = Set Press Temperature
- 4.) Right side SV value = Set Press Time

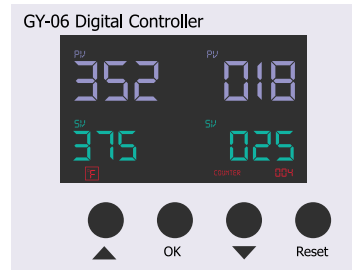

Setting Press Temperature

Press OK to start. Use the up and down arrows to choose to display in °F or °C.

°F stands for Fahrenheit

°C stands for Celsius

Once selection is made, press OK to save.

Green set temperature value will flash.

Use the up and down arrows to set press temperature value. Press ok to save



Note: Setting the press temperature to above 400°F (200°C) may cause a fire hazard.

Setting Press Time

Green Set Time Value will flash

Use the up and down arrows to change the value.

Press ok to save the value.

Wait until the current temperature is the same as the set temperature before using. The press will beep once set temperature is reached. Close and open the press to stop the beeping.



Operating Instructions

Pressing a T-shirt

- 1.) Turn ON the Main Power Switch.
- 2.) Set the appropriate Press Temperature, and Time as per your transfer vinyl, transfer paper or sublimation instructions. Adjust the pressure if necessary. Unlock the pressure crank. To adjust the pressure turn the crank below the base plate clockwise to increase pressure and counter-clockwise to decrease pressure. Once pressure is adjusted, lock the pressure crank.
- 3.) Unlock the brake handle and swing the platen (using the swing handle) to the right away from the base plate.
- 4.) Place your T-shirt on the heat press.
- 5.) Wait until current temperature is the same as the set temperature. Once the press has reached set temperature, place transfer material on the shirt. For Sublimation, place the paper with the image face down. For cuttable transfer vinyl, place the matte side with the transparent carrier backing facing the heat platen. If unsure, please refer to the instructions you received with your transfer materials.
- 6.) Swing the heat platen (using the swing handle) on top of the base plate, then lock the brake handle. Close the press.
- 7.) Once Press is closed the current time value will start counting down. Once the timer reaches the last 2 seconds before reaching 0, it will start to beep to warn you. It is recommended to stand clear of the press and let the auto-open feature work without obstruction. Once time reaches zero, the press will open. Unlock the brake handle and swing heat platen away (using swing handle) from base plate. Remove heat pressed materials from base plate.

Note: Once the press is closed, it cannot be opened manually until the timer reaches zero. In an emergency, you may press the red emergency stop button to force open the press. When pressing the red emergency stop button, the press will open immediately without warning. Keep hands on the heat press handle at all times during and after pressing the emergency stop button. Not securing the handle with your hands may cause injury.

- 8.) For most sublimation and transfer vinyl, the peel is hot. If unsure, refer to the instructions that came with your transfer materials.

Maintenance

General Maintenance

Please switch off the machine and unplug the power cord when the machine is not in use.

To protect the heat platen, do not allow any hard surface objects to be in direct contact with the platen. This includes zippers, buttons, metal sublimation items. When pressing these items, place a protective sheet between the platen and the objects.

The heat platen will cool down to the room temperature, if heat press is not used for more than 30 minutes.

The heat-releasing fan will automatically starts when the temperature of heat platen reaches 80 degree C (176 degree F). It helps to reduce the temperature of electrical parts and prolong the service life of them.

Please add the lubrication oil regularly on the joints. To prolong the life of your heat press. The frequency will depend on how often you use your machine.

Note: This heat press should not be set to exceed 400°F (200°C). Setting the press temperature to above 400°F (200°C) may cause a fire hazard.



If your heat press stops working, please contact Joto at 1-800-565-5686 so we can help you troubleshoot.

Heat Pressing Guide

Transfer Vinyls

MultiCut One-4-All

Temperature: 265°F
Time: 3-5 seconds
Peel: Warm (Cotton)



MultiCut Premium

Temperature: 310-330°F
Time: 45 seconds
Peel: Warm/Cool



MultiCut New Flock

Temperature: 310-330°F
Time: 15 seconds
Peel: Warm



MultiCut Lustre

Temperature: 310-330°F
Time: 15-20 seconds
Peel: Hot to Cold



MultiCut Nylon

Temperature: 300-305°F
1st Press Time: 3-4 seconds
2nd Press Time: 10-15 seconds



MultiCut Style

Temperature: 310-330°F
Time: 15-20 seconds
Peel: Hot to Cold



For more instructions, please visit our website at www.jotoimagingsupplies.com/support/how-to-library/instructions.html

Transfer Papers

CL TrimFree Dark

(REQUIRE A WHITE TONER PRINTER)

Temperature: 310°F
1st Press Time: 120 seconds
2nd Press Time: 30 seconds



CL TrimFree Light

Temperature: 330°F
Time: 30 seconds
Peel: Warm (5-10 seconds)



Inkjet Light

Temperature: 350-365°F
Time: 20 seconds
Peel: Warm



Inkjet Dark

Temperature: 375°F
Time: 20-25 seconds
Peel: Cool



For more instructions, please visit our website at www.jotoimagingsupplies.com/support/how-to-library/instructions.html

www.jotoimagingsupplies.com 1-800-565-5686 Blaine, WA | Las Vegas, NV | Antioch TN | Coquitlam, BC | Brampton, ON

Heat Pressing Guide

Sublimation Items

Sublimatable Ceramic Tiles

Temperature: 400°F
Time: 360-420 seconds
Peel: Hot
Method: Substrate face down
Image face up



iLumipiX Photo Panels

Temperature: 400°F
Time: 65-150 seconds

Time may varied based on size.
Scan the QR code on the left for instructions or visit our website.



Porcelain Ornaments

Temperature: 400°F
Time: 180-240 seconds
Peel: Hot
Method: Substrate face down
Image face up



Sublimatable Towels

Temperature: 360°F
Time: 120 seconds
Peel: Hot
Method: Substrate face up
Image face down



Coasters with Cork Bottom

Temperature: 400°F
Time: 75 seconds
Peel: Hot
Method: Substrate face up
Image face down



Sublimatable Pillows

Temperature: 375°F
Time: 45 seconds
Peel: Immediate
Method: Substrate face up
Image face down



Pot Holder

Temperature: 360°F
Time: 120 seconds
Peel: Immediate
Method: Substrate face up
Image face down



Sublimatable Slates

Temperature: 360°F
Time: 480 seconds
Peel: Immediate
Method: Substrate face up
Image face down



For more instructions, please visit our website at www.jotoimagingsupplies.com/support/how-to-library/instructions.html

Expanded Diagram

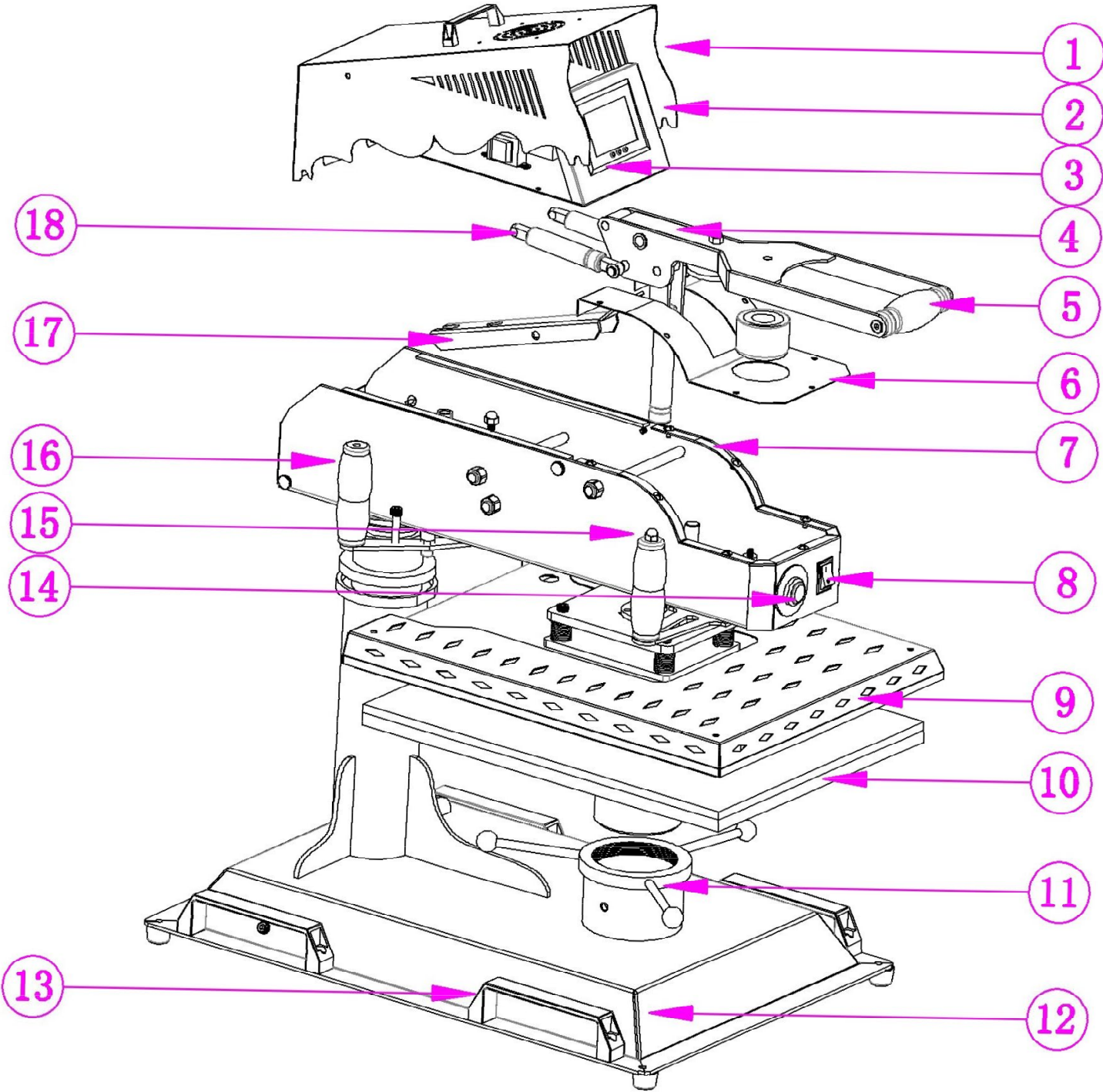

Expanded Diagram

Serial No.	Part Name	Qty
1	Electrical Case Cover	1
2	Electrical Components	1
3	Digital Controller	1
4	Handle Shaft	1
5	Handle Bar Grip	1
6	Front Cover Case	1
7	Swing Shaft	1
8	Power Switch	1
9	Heat Platen	1

Serial No.	Part Name	Qty
10	Under Plate	1
11	Pressure Adjusting Knob	1
12	Machine Base	1
13	Lift Handle	1
14	Emergency Stop Button	1
15	Swing Handle	1
16	Braking Handle	1
17	Clutch Lever	1
18	Gas Spring	1

Circuit Diagram

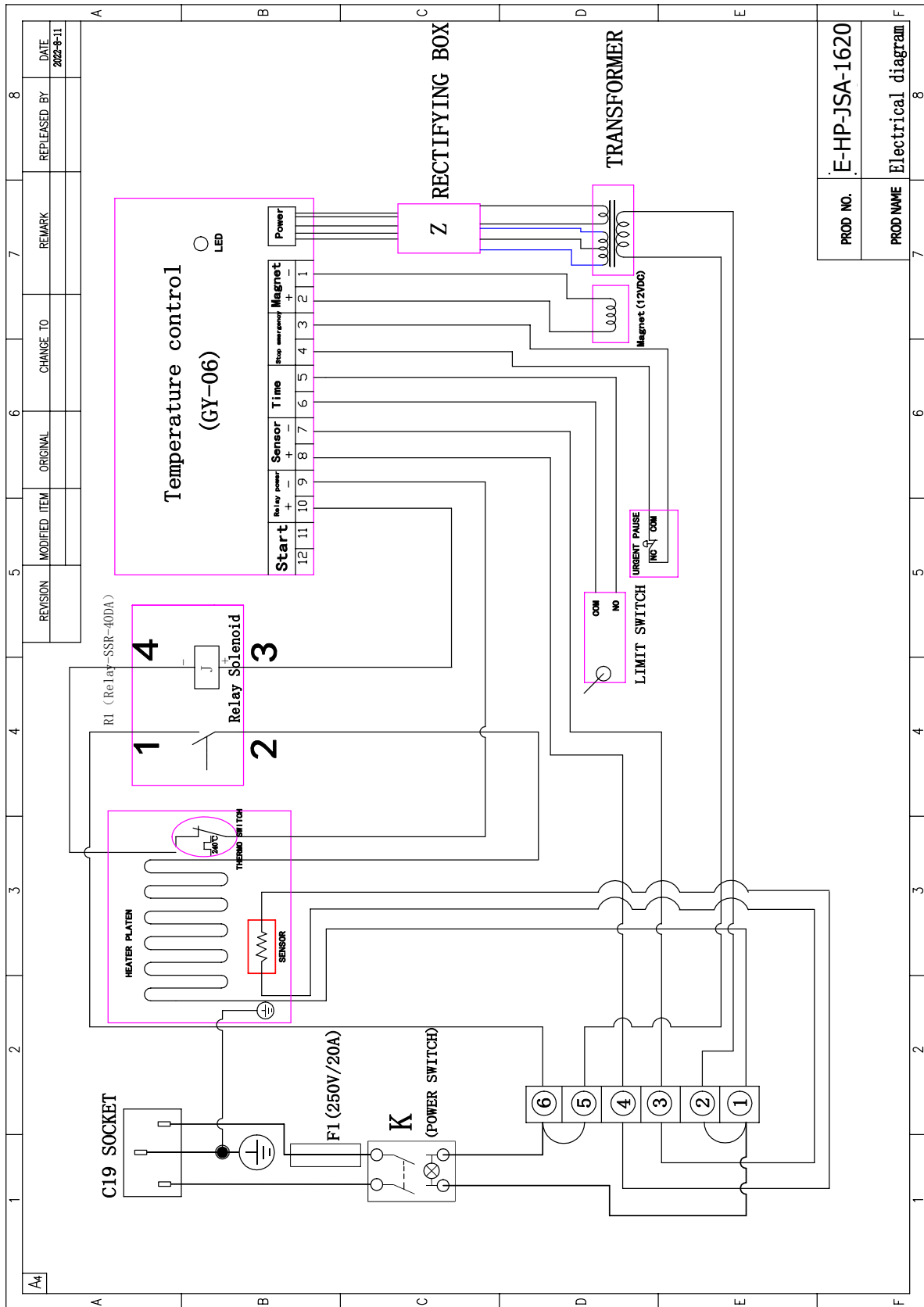

PROD NO.	E-HP-JSA-1620
PROD NAME	Electrical diagram

Warranty Statement

JOTO warrants to the original purchaser JOTO's E-HP-JSA-1620 heat presses or component that such heat press or component is free from defects in materials and workmanship, subject to the limitations set forth below.

IN LIEU OF ALL WARRANTIES, EITHER EXPRESS OR IMPLIED, INCLUDING WITHOUT LIMITATION ANY IMPLIED WARRANTY OF MERCHANTABILITY OR FITNESS FOR A PARTICULAR PURPOSE, WHICH JOTO HEREBY DISCLAIMS, THE OBLIGATIONS OF JOTO UNDER THIS WARRANTY ARE EXPRESSLY LIMITED TO THE FOLLOWING:

- a. JOTO will repair or replace at its option, free of charge, any product, component of its products, and any component it sells separately which is installed in JOTO's heat presses, within twenty-four months and sixty months for the heating platen after shipment by same.
- b. This warranty does not apply to damage incurred in shipment. Damage incurred in shipment should be reported to the designated carrier. It is the carrier's responsibility to ensure arrival in undamaged condition.
- c. Service labor, when requested in connection with any of the above items covered by this warranty, will be charged for traveling expenses only.
- d. This warranty applies only if the product or component proves to be defective under conditions of normal use. It does not apply to breakage or to defects resulting from accident, alteration, misuse, or improper installation.
- e. This warranty does not include installation of the product or component.
- f. Prior to any return of a product or component, Buyer must receive written authorization to do so from JOTO. After written authorization, Buyer shall return the defective product or component freight prepaid by the original purchaser and JOTO will ship the replacement or repaired component freight prepaid by JOTO.
- g. This warranty is effective only if the product or component is installed in a location and manner prescribed by JOTO instructions and only if it is maintained in accordance therewith. This warranty shall become ineffective if the product or component is altered by anyone other than JOTO employees. JOTO neither assumes, nor authorizes any person to assume for it, any obligation or liability other than as specified herein.

JOTO WILL IN NO CASE AND UNDER NO CIRCUMSTANCES BE LIABLE FOR SPECIAL OR CONSEQUENTIAL DAMAGES, LOSS OF PROFIT OR COMMISSION, OR FOR LOSS OR DELAY IN PRODUCTION.

Without limiting the generality of the foregoing, JOTO will not be liable with respect to furnishing or delay in furnishing any product or component, the use, resale or other disposition thereof, failure to furnish the same, or any other cause. JOTO liability arising out of the supply of any product or component, its use, resale or other disposition, or out of any guarantee or warranty, express or implied, or any other cause shall in no case exceed the cost to JOTO of the product or component which JOTO has agreed to supply. All liability of JOTO with respect to any product or component shall terminate upon the expiration of the twenty-four month period described above.

-Any controversy or claim arising out of or relating to transactions or orders or breach thereof, including breach of warranty, shall be settled by arbitration in Blaine, Washington, pursuant to the rules of American Arbitration Association. Any award made against JOTO shall be limited as provided above. Judgment upon award rendered by arbitration may be entered in any court having jurisdiction thereof. However, at JOTO's option, this paragraph shall not apply to collection by JOTO of the price of any product sold or any action related thereto.



**PLEASE KEEP THE BOX THAT YOUR HEAT PRESS ARRIVED IN,
ALONG WITH ALL ORIGINAL PACKAGING.**

JOTOTM

The logo for JOTO features the word "JOTO" in a large, bold, black serif font. A red swoosh underline is positioned beneath the letters "O" and "T", extending from the left side of the "O" and tapering off to the right.

Bringing images to lifeTM

www.jotoimagingssupplies.com

Tel: 1-800-565-5686

Fax: 1-800-565-5622

Coquitlam, BC | Brampton, ON

Blaine, WA | Las Vegas, NV | Antioch TN